

Chaînes simples de suspension

63 a 220 KV pour fixation de protection côté ligne

Single suspension strings

63 to 220 KV for line end protection

Cadenas de suspension sencillas

63 hasta 220 KV para proteccion lado conductor

TRANSPORT
TRANSMISSION LINES
TRANSPORTE



1003-04
8710

CARACTÉRISTIQUES TECHNIQUES / TECHNICAL DATA / DATOS TECNICOS

Isolateur	Norme/Standard/Norma							
	16	20	16	20	16	20	16	20
	16	20	16	20	16	20	16	20
H (mm)	150	200	188	225	130	175	130	145
F (daN)	12000	16500	12000	16500	12000	16500	12000	16500
D (mm)	18	20	16	18			16	18
E (mm)	70	70	20	20			22	22
Poids Weight (kg) Peso	1,055	1,510	1,125	1,510	0,850	1,325	1,105	1,415

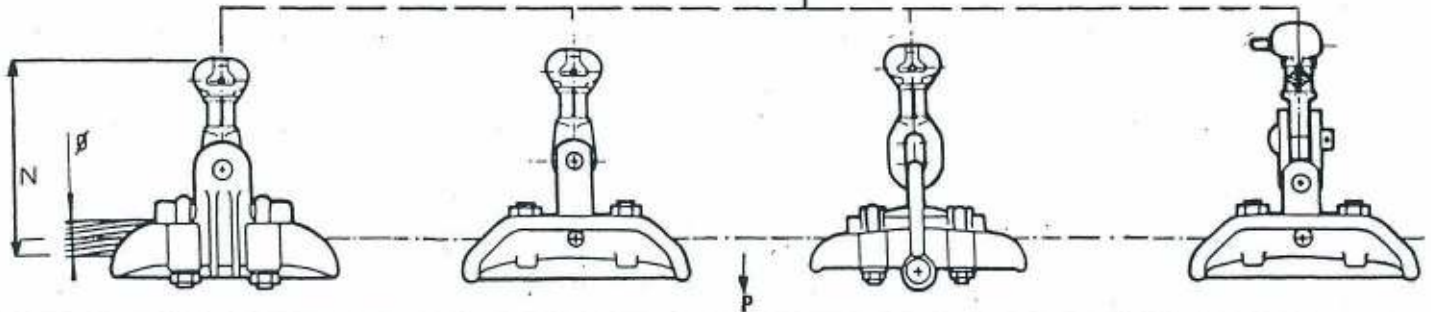
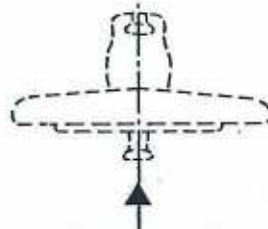
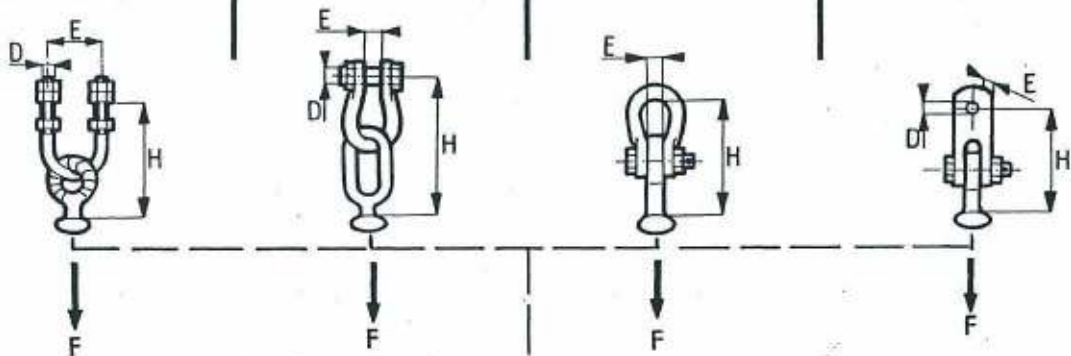

Ø mm	mini	8	14	23	40	12	14	25	35	4	13,5	19,6	22,7	12	14	25	35
	maxi	18,5	23	35	50	18	26	38	52	12,2	19,6	22,5	33	18	26	38	52
P (daN)		8000	8000	12000	12000	8000	8000	12000	12000	3000	7000	10000	12000	8000	8000	12000	12000
N (mm)		180	180	192	203	190	190	200	200	197	204	237	232	230	230	245	255
16	Poids Weight (kg) Peso	1,780	1,945	2,520	2,995	2,530	2,500	3,480	3,715	1,580	2,035	2,660	3,145	3,160	3,130	4,070	4,260
	N (mm)	190	190	202	213	200	200	210	210	197	204	237	232	240	240	255	265
20	Poids Weight (kg) Peso	2,200	2,400	3,015	3,560	2,975	2,945	3,975	4,280	1,955	2,410	3,035	3,520	3,580	3,550	4,490	4,680
	N (mm)																

Chaînes simples de suspension
63 a 220 KV pour fixation de protection côté ligne
Single suspension strings
63 to 220 KV for line end protection
Cadenas de suspension sencillas
63 hasta 220 KV para proteccion lado conductor

TRANSPORT
TRANSMISSION LINES
TRANSPORTE



1003-05
8710

RÉFÉRENCES / CAT. NB / REFERENCIAS

	16	20	16	20	16	20	16	20
①	E 18.70	E 20.70						
② ④ ⑤	OR 16	OR 20	OR 16 OL	OR 20 O	OR 16 T	OR 20T	OR 16T	OR 20T
③			M7B 20	M18B	M7B 20	M18B		
⑥							CA 120FB	CA 160FB

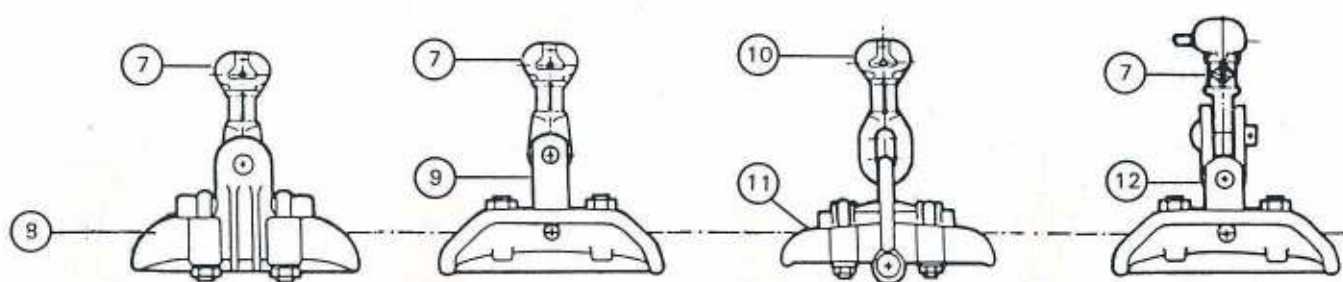
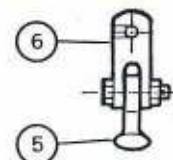
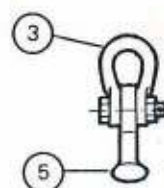
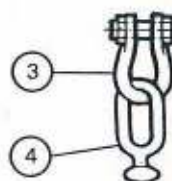
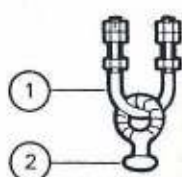

Ø (mm)	mini	maxi	16				20				16					20			
			BS16 CT	BS16 CT 22	BS16 CT 34	BS16 CT 50	BS16 CT 22	BS16 CT 22	BS16 CT 34	BS16 CT 50	BS16 CO					BS16 CT			
			BS20 CT	BS20 CT 22	BS20 CT 34	BS20 CT 50	BS20 CT 22	BS20 CT 22	BS20 CT 34	BS20 CT 50	BS20 CO					BS20 CT			
			AR 1D 18*	AR 1D 22*	AR 1D 35*	AR 1D 45*	AE 2D 12-18-2*	AE 2D 14-18-2*	AE 2D 25-38-2*	AE 2D 35-52-2*	4D 76 M300 *	4D 147 M300 *	4D 228 M2 *	4D 301 M15 *	4D 612 M15 *	AE 2D 12-18-3*	AE 2D 14-26-3*	AE 2D 25-38-3*	AE 2D 35-52-3*
			8	14	23	40	12	14	25	36	4	9,45	13,5	19,6	22,7	12	14	25	36
			18,5	23	35	50	18	26	38	52	12,2	16,5	19,6	22,5	33	18	26	38	52

* Ajouter B ou R par boulon ou axe rivet (ex AR1D 18B)
Add B or R for bolt or rivet (i.e. AR1D 18B)
Añadir B o R para perno o remache (ex AR1D 18B)